

# EM-FINITY CLOSURE

Your Closure, Your Way. **Connect Beyond Limits**

1056+ splices / 96 LC Pre-connectorised customers

## Modular Splice Closure System

- Fully Customisable
- Colour Coded
- Custom Fitted
- 4 Sizes



# INTRODUCING

Another innovation by Emtelle



## The Premier Solution for Seamless Network Expansion

EM-Finity enhances the traditionally complex process of network expansion into a streamlined, efficient, and straightforward experience. Our design simplifies expansion, significantly reducing both time and resource expenditure.

Moreover, EM-Finity sets a new benchmark for quality and reliability in splice closures, a critical component of drop networks. Our extensive testing guarantees superior performance and durability, ensuring that your investment delivers long-lasting value.

The intuitive, colour-coordinated design of EM-Finity facilitates easy network management and adaptability to future demands, providing you with the confidence to meet evolving technological requirements.

## EM-Finity Sustainable Benefits

The colour-coded system speeds up installation and management, reducing time, resources, translating into less environmental impact. The modular design allows for easy upgrades, and its energy-efficient manufacturing process cuts carbon emissions. Additionally, the compact design reduces fuel use in transport, and our efficient distribution strategy cuts emissions from transportation.

### Dual Purpose

Mechanical seals can be used for both duct & cable.

### Modular System

Customisable and upgradable to meet your exacting requirements.

### Lift & Lock System

Quick release clamp with locking option.

### One Tray - Multiple Uses

A standard tray with 12 splices can also hold 2 splitters, efficiently combining both functions in a single unit.

### Industry Leading Material

Constructed from high quality, corrosion resistant materials.





## KEY BENEFITS

### Definition of Simplicity

Our solutions combine ease of use with advanced functionality, ensuring a streamlined, future-ready network.

### Bespoke Splice Closure

Designed to fit your exact specifications, ensuring seamless integration and superior network performance.

### Colour Coded Management System

From colour coded port entries, trays and pre-connectorised adapter ports. Emtelle's colour coded cable management system allows you to manage your network from start to finish.

### Upgradable System

Allowing more splice tray capacity, perfect for future network growth.

### Versatile Solution

One closure designed for both mechanical (gel) and heat-shrink cable or microduct entries.

Quick and easy fibre management between each side of the closure, with a safe and innovative cable slack storage basket that is retained in the middle of the closure.



Disclaimer: EM-Finity can only be used in certain countries that support overhead networks.



# SIZES FOR ANY APPLICATION

With fibre networks growing and expanding every day worldwide, EM-Finity can grow as your **future fibre** capacity grows.

There are 4 standard EM-Finity sizes - S, M, L and Lite, which can give you a wide range of splicing and patching options to meet your network build needs for now and the future.

## EM-FINITY CLOSURES

Model	Approx Size (W x L)	Splice / ANT Capacity	Max Pre-Con Capacity	Trays Per Dome	Total Splice Capacity
Lite	185 x 390mm	24 per tray	24 LC / APC 12 SC / APC	6	144
Small	285 x 388mm	12 per tray	48 LC / APC 24 SC / APC	24	288
Medium	285 x 512mm	12 per tray	96 LC / APC 48 SC / APC	56	672
Large	285 x 635mm	12 per tray	96 LC / APC 48 SC / APC	88	1056

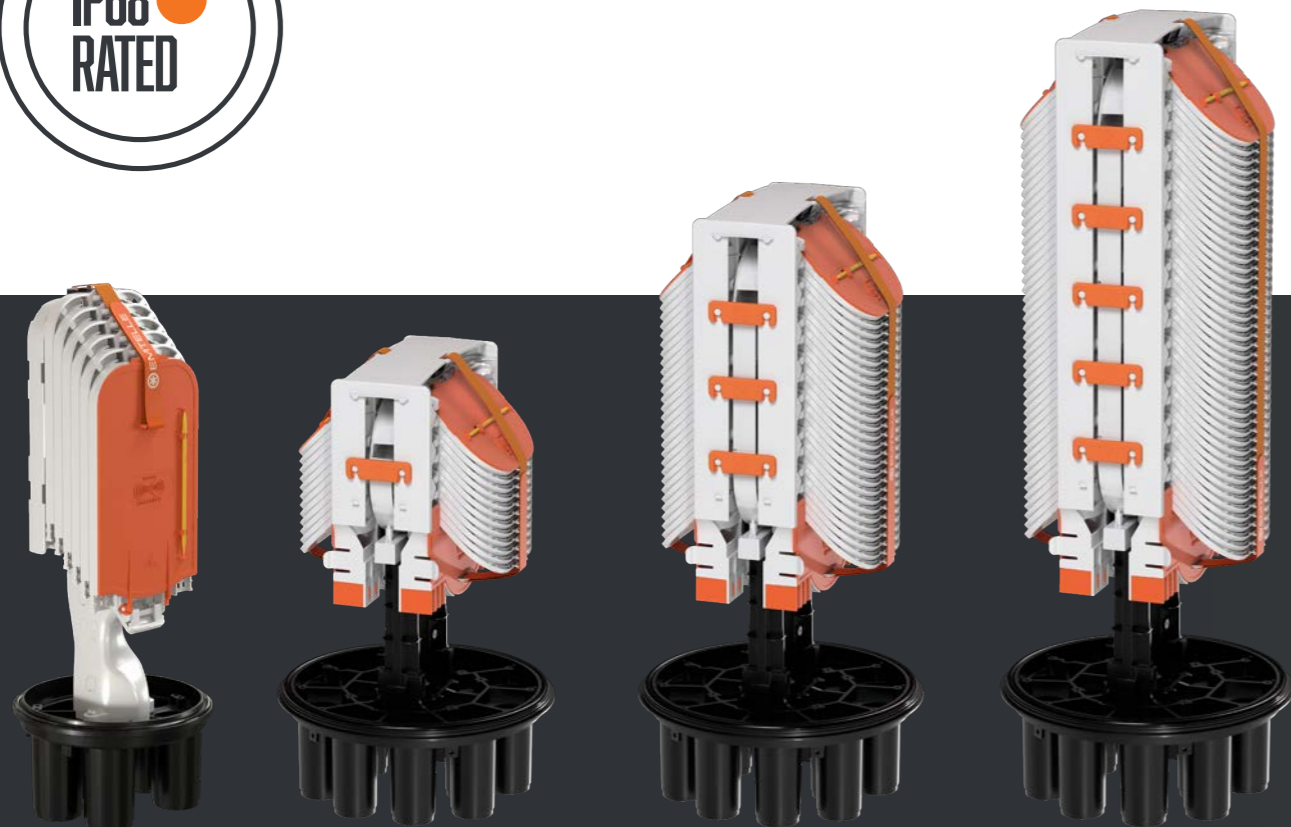

# FIBRE INSTALLATION WITH A COLOUR-CODED SYSTEM

EM-Finity takes simplicity and efficiency to the next level with its **coloured system**. Extending from coloured port entries to corresponding trays. Traceability of fibre is greatly improved as a result of these features.

This colour-coded design transforms the installation into a seamless and quick task, allowing for easy identification at a glance. The benefits extend beyond installation; the colour-coded system ensures ongoing simplicity throughout the network. Adhering to recognised standards becomes self-explanatory for technicians, minimising errors and streamlining maintenance.

- Reduce Errors ✓
- Simplify Record Keeping ✓
- Accelerate Fault Detection ✓

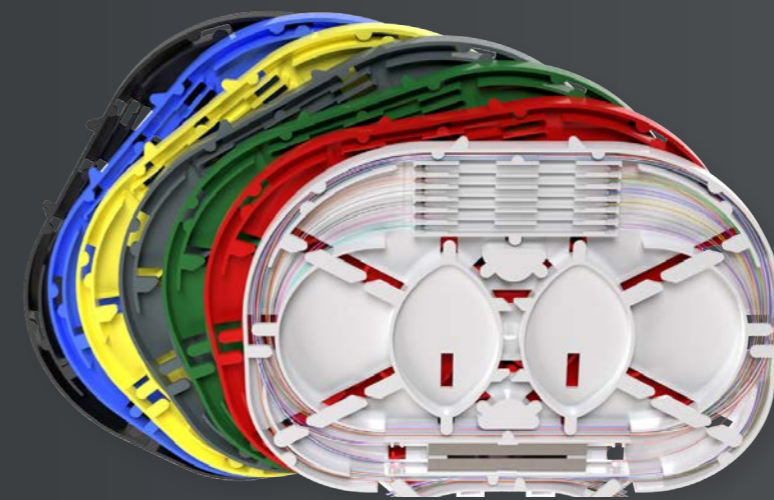
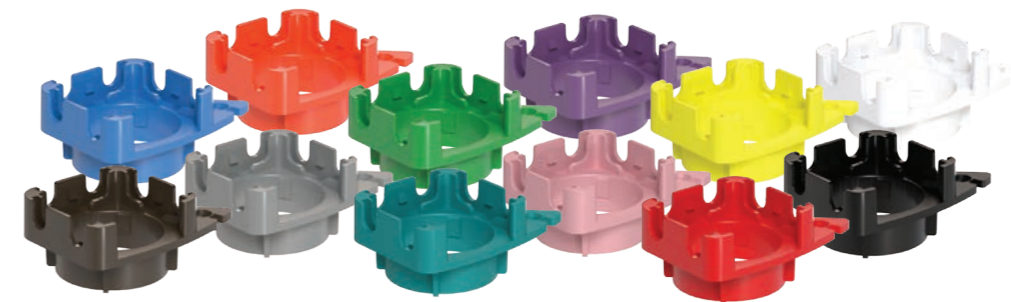



# PRE-CONNECTORISED

EM-Finity is your ticket to unmatched efficiency and flexibility for a seamless integration process - a **pre-connectorised** option for ultimate ease is offered as part of the range.

**Mix-and-Match Flexibility:** With the Pre-Connectorised EM-Finity, you can customise your dome to suit your needs. Whether you require partial or complete pre-connectorisation, we've got you covered. This is not just a one-size-fits-all solution, but a solution that can be tailor made to your exact requirements.

**Choice of Connectors:** We understand that every network is unique, so we offer pre-connectorisation with either LC or SC/APC connectors. Whether you prioritise performance or compatibility, rest assured that our pre-connectorised solution will meet your requirements with precision.

**Colour-Coordinated Clips:** Our priority is keeping your installation process organised and efficient. That's why we've gone the extra mile to colour-coordinate the clips on our fibre adapter mounts—with our intuitive design; you can ensure a seamless installation process every time.

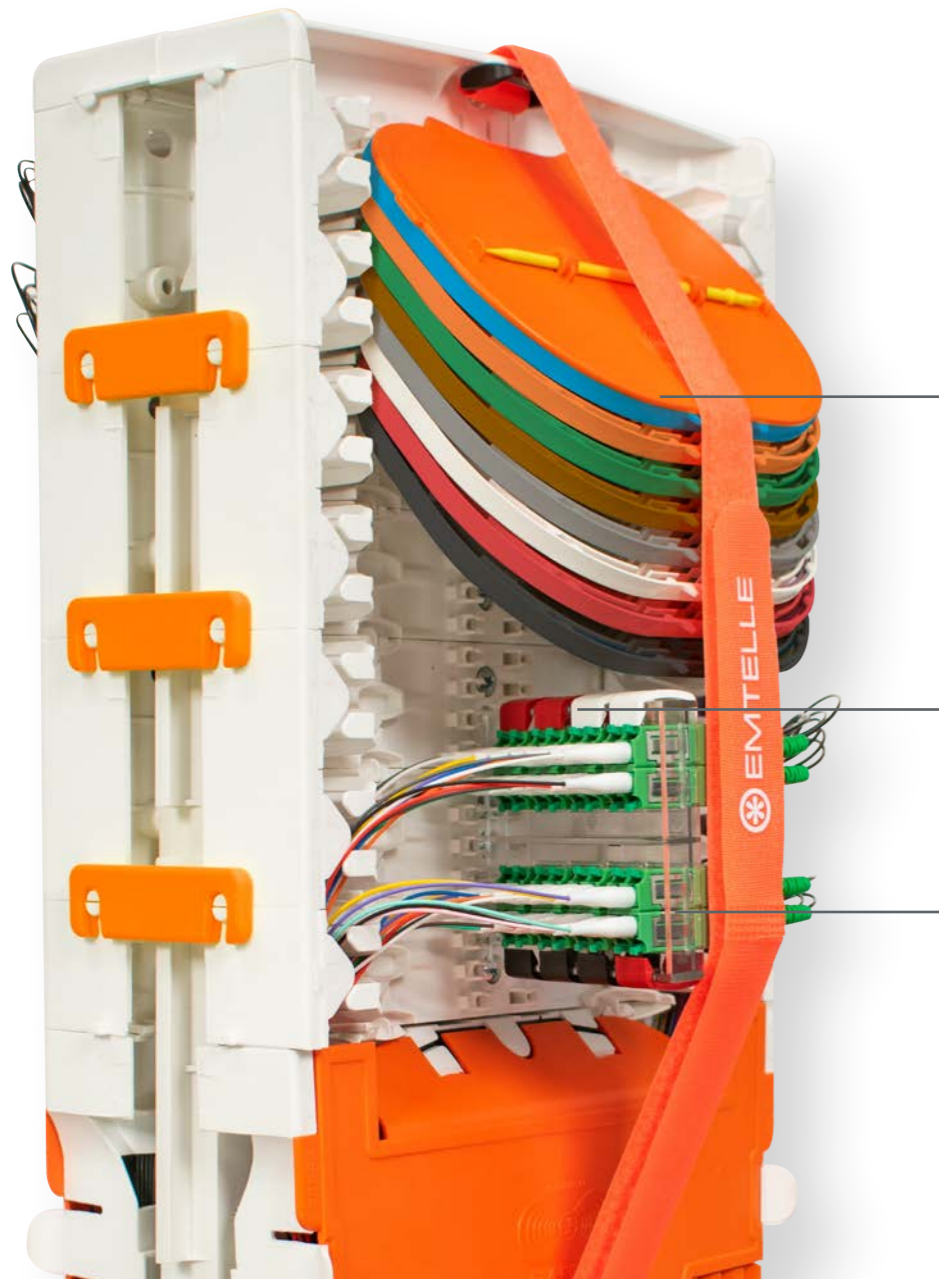

96 customer connections max.

Splitters or splice trays can accommodate PLC splitters, fusion splicing, ribbon splicing and ANT type splice protectors. With fibre management for front to back routing of the fibres.

Unique colour coded fibre adapter mounts and coloured pigtails makes installation and identification simple, quick and self-explanatory.

One modular fibre adapter mount can hold up to 32 customers.

Up to 96 individual drop ports available on the base.

# MIX & MATCH

Have fibre splicing and pre-connectorised networks in **one closure**.

A closure that supports both fibre splicing and pre-connectorised solutions offers unparalleled flexibility, efficiency, and reliability. It streamlines deployment by accommodating different project requirements, reducing installation time, and minimising costs. This versatility ensures scalability, simplifies maintenance, and future-proofs the network against evolving technologies. In essence, it combines the benefits of both methods to provide a versatile and future-ready solution for modern network deployments.

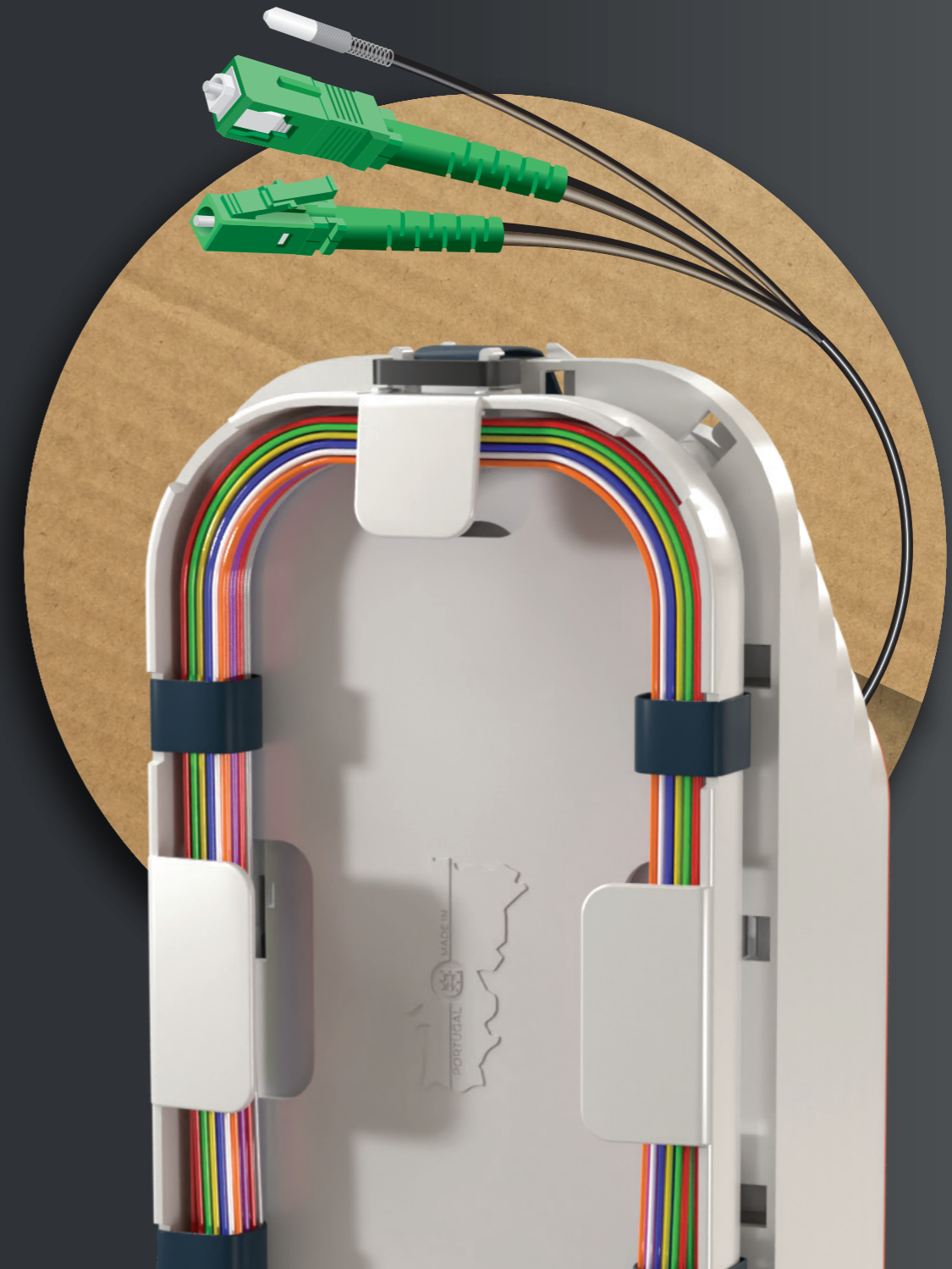



# PORTS & SEALS

We are enabling Engineers for **Future-Ready** Networks.

Seal cable & microduct entries effortlessly with our range of mechanical gel seals, or heatshrink if preferred. Our all inclusive kits streamline cable preparation and installation, providing technicians with a hassle free solution for both current needs and future expansion.

Stay ahead of the curve with EM-Finity, ensuring efficient and adaptable networks for years to come.

- 1**  Oval port for 5-12mm cables
- 2**  8 x 4-6mm
-  12 x 5mm
-  6 x 6-8mm
-  2 x 8-10mm, 2 x 10-12mm

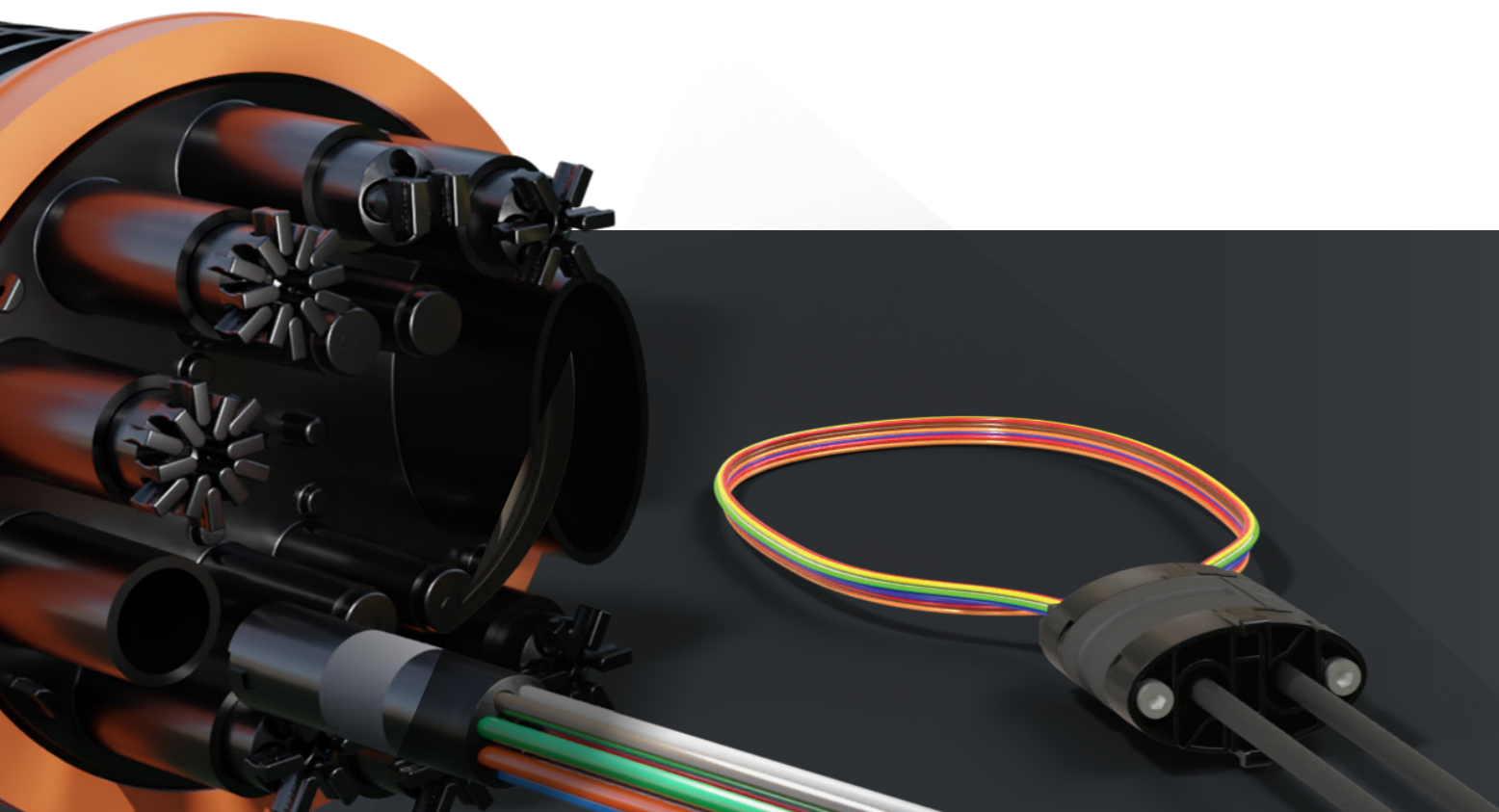

# EXPANSION KIT

Increase capacity by **384 splices**

Your gateway to transformative **network expansions**.

The small, medium & large (splice only) closures can be expanded to accommodate more fusion splices or splitters. Simply add our unique expansion ring and then install the modules with the relevant number of trays to configure it your way.

**Expansion Kit:** Available to increase number of splices by 384 splices per expansion kit or increase Pre-connectorised customer drops (Maximum 96).



# FTTH FULL SOLUTION



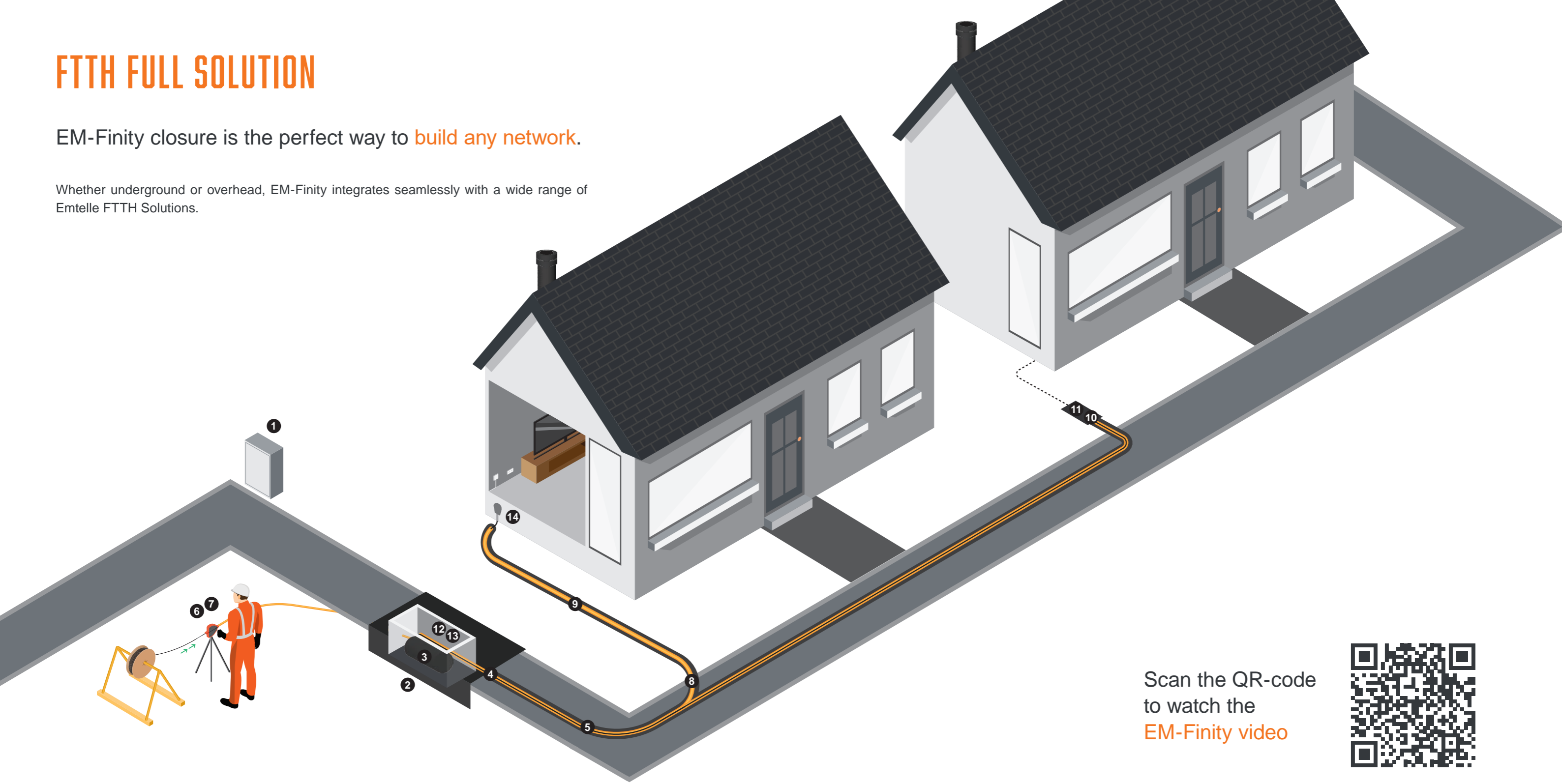

EM-Finity closure is the perfect way to **build any network**.

Whether underground or overhead, EM-Finity integrates seamlessly with a wide range of Entelle FTTH Solutions.



Scan the QR-code to watch the **EM-Finity video**

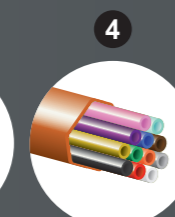
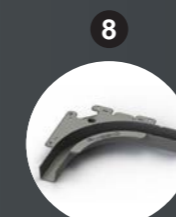
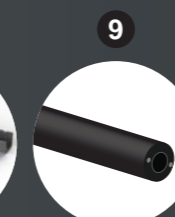
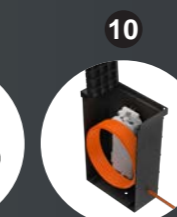

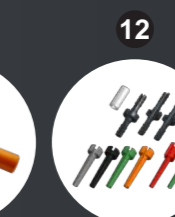
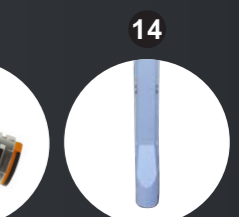
- |   |   |   |   |   |  |   |   |   |   |   |   |   |   |
|---|---|---|---|---|--|---|---|---|---|---|---|---|---|
|  |  |  |  |  |  |  |  |  |  |  |  |  |  |
| Cabinet   | Access Chamber  | EM-Finity Closure   | Microduct / Tube Bundle   | QWK REVOLink3   | DropDrive  | Lubricant   | EM-Bend   | Universal Drop Tube   | Toby Box+   | EM-Marker   | ELF   | Connector   | Trunking  |



# FULL SOLUTION OVERVIEW

## Recommended Products

Our solutions are made to perfectly complement your network installations, working together seamlessly for optimal performance.



**Cabinet** - Suitable for dense distribution of customer connections and large distribution cables. Customer connections can be directly spliced or distributed through the LGX splitter modules.



**Access Chambers** have been designed for both footway and carriageway installations, where they provide access to underground ducting.



**Universal Drop Tube** is used as a customer drop tube for a variety of installations – it can be used overhead, in duct, along walls or directly buried. With GRP strength members in the wall, the Universal Drop Tube is spade resistant.



**Toby Box+** is a compact access point from where a technician can easily maintain and install customer connection infrastructure. It can be used to store excess cable slack or fit a compact splice closure.



**EM-Finity Lite** has the capability to have either 144 splices, or 12 SC or 24 LC pre-connectorised customers.

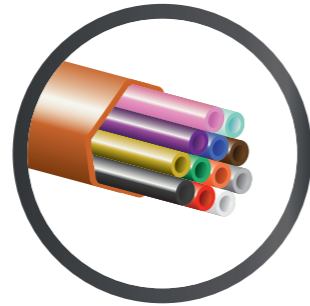

**Tube Bundles** each boasting microducts with low friction performance. With a robust, thin & tough sheath that envelops each tube bundle, ensuring unmatched protection and durability.



**EM-Marker** is a compliant telecommunication underground marker that is placed underground to easily trace key points of infrastructures. Other uses include being used as an end cap or with the EM-Bend.



**Emtelle Fibre Lock System** to eliminate lateral movement of terminated microcables due to vibration or thermal expansion / contraction of the duct system. Design specifically for Emtelle FibreFlow products.

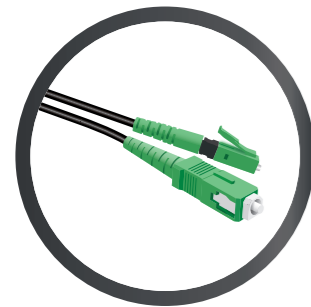

**QWKREVOLink3** is a pre-connectorised fibre drop cable for FTTx installation. Streamlining the installation process and considerably lowering the capital expenditure typically required for installation equipment.

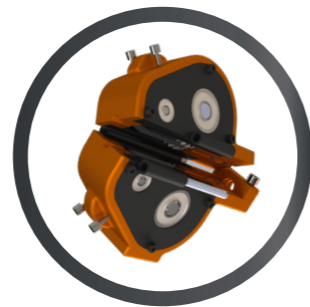

**DropDrive** Emtelle's cutting-edge drill-assisted pushing machine designed to seamlessly enhance fibre optic pushing installations. Making fibre drop solutions available to the masses.



**Push-fit Connectors** are suitable for use with FibreFlow microducts of the same size. They ensure a seamless and airtight connection when blowing fibre cable at up to 15 bar working pressures.

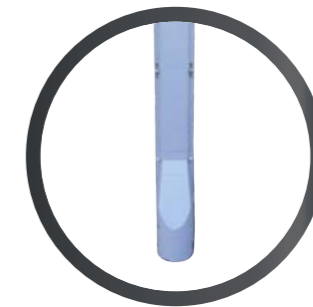

**External Customer Lead In** and through wall protection of fibre optical customer drop cable.



**Lubricant** reduces frictional drag during the blowing of small diameter fibre optic minicables into microducts.



**EM-Bend** product is designed to be quick and easy to install only using cable ties. It offers a smooth 90° bend while protecting the tube connector for optimal cable blowing performance. Can also be used as an L/T-branch.





## CONTACT US

### **Emtelle Group**

Allan House, Floor 4  
25 Bothwell Street  
Glasgow, G2 6NL  
United Kingdom

 **+44 (0) 1450 364 000**  
 **info@emtelle.com**

### **Emtelle Hawick, UK**

Haughhead  
Hawick  
TD9 8LF  
United Kingdom

 **+44 (0) 1450 364 000**  
 **info@emtelle.com**



### **Emtelle Jedburgh, UK**

Oxnam Rd  
Jedburgh  
TD8 6NN  
United Kingdom

 **+44 (0) 1450 364 000**  
 **info@emtelle.com**

### **Emtelle Ridgmount Technologies Ltd**

Unit 5, Field Farm  
Business Centre,  
Launton, OX26 5EL  
United Kingdom

 **+44 (0) 1869 277 233**  
 **info@ridgmount.com**



### **Emtelle Scandinavia**

Vardevej 140  
7280 Sønder Felding  
Denmark

 **+45 86 28 84 88**  
 **salg@emtelle.com**

### **Emtelle GmbH**

An der Flurscheide 20  
99098 Erfurt  
Germany

 **+49 (0) 361 654 330**  
 **info-de@emtelle.com**

### **Emtelle UAE**

Plot 597-896  
Dubai Investment Park  
Dubai  
UAE

 **+971 4 883 1608**  
 **info@emtelle.com**

### **Emtelle USA**

101 Mills Gap Rd  
Unit A, Fletcher  
NC 28732  
USA

 **+1 (828) 7079970**  
 **info@emtelle.com**

